

A Comparative Study of the Effectiveness of Indigenously Developed Knee-Ankle-Foot Orthosis with Stance Control Knee Joint and Knee-Ankle-Foot Orthosis with Drop Lock Knee Joint in Post-Polio Residual Paralytic Patients

Manoj Kumar Tiwari¹, Yogeeta Madkaikar², Dr. Anil Kumar Gaur³,
Deepak P. Prabhu⁴

¹Department of Prosthetics & Orthotics, All India Institute of Physical Medicine and Rehabilitation, Mumbai, India

²Department of Prosthetics & Orthotics, All India Institute of Physical Medicine and Rehabilitation, Mumbai, India

³All India Institute of Physical Medicine and Rehabilitation, Mumbai, India

⁴Department of Prosthetics & Orthotics, All India Institute of Physical Medicine and Rehabilitation, Mumbai, India

Corresponding Author: Manoj Kumar Tiwari

DOI: <https://doi.org/10.52403/ijhsr.20221118>

ABSTRACT

Background and purpose: Individuals with quadriceps weakness have difficulty generating the knee-extension moments required to complete everyday mobility tasks. Patients with quadriceps muscle weakness are often prescribed a knee-ankle-foot-orthosis (KAFO), which locks the knee in full extension during both the stance and swing phases of gait. Abnormal gait patterns are characterized by hip hiking and leg circumduction during the swing phase due to the locked knee. A stance control knee-ankle-foot-orthosis (SCKAFO) was developed to provide active flexion and extension of the knee joint during the swing phase of gait and restriction of the knee joint during the stance phase, thereby supporting the limb during weight-bearing. The developed design consists of a knee joint controlled electro-magnetically, allowing free knee flexion during the swing and secured stance phases in poliomyelitis patients. This study aimed to evaluate the potential of the indigenously developed SCKAFO with electro-magnetically controlled knee joint by determining its effect on spatiotemporal gait parameters, the physiological cost index (PCI), and improving quality of life in poliomyelitis patients compared to when walking with a KAFO with drop lock knee joint.

Methodology: By convenience sampling, five subjects of poliomyelitis with quadriceps weakness fulfilling the inclusion criteria were enrolled in the study. A custom-made stance control knee-ankle-foot orthosis (SCKAFO) with the same components was constructed for each participant. Gait analysis was performed on each patient with KAFO with drop lock knee joint and SCKAFO. Energy expenditure was measured by calculating the Physiological Cost Index (PCI), and the Orthotics Prosthetics Users Survey-Health Quality of Life Index (OPUS: HQOL) questionnaire was administered to assess the quality of life of poliomyelitis patients.

Results: Indigenously developed SCKAFO is significantly effective in increasing step length, stride length, cadence, and speed, reducing the physiological cost index, and improving the health quality of life of the patients. Walking with the SCKAFO significantly increased walking speed ($p=0.03$) and other spatiotemporal gait parameters and reduced PCI ($p=0.03$) compared to walking with the locked KAFO.

Conclusion: SCKAFO significantly improved spatiotemporal gait parameters and quality of life and reduced energy expenditure of poliomyelitis patients in walking. Compensatory movements, which

were indispensable for walking with a locked knee, were reduced. Thus primary outcome measures were achieved during walking for poliomyelitis subjects with SCKAFO.

Clinical Relevance: This newly developed SCKAFO design improved the PCI of walking for people with post-polio residual paralysis compared to walking with a locked KAFO. The SCKAFO may contribute to improved quality of life and health status of persons with lower-extremity impairments by providing the ability to have better walking speed, endurance, and functional balance.

Keywords: Knee-ankle-foot orthosis, stance control knee-ankle-foot orthosis, spatiotemporal, gait, quadriceps, walking

INTRODUCTION

Neuromuscular diseases, mainly poliomyelitis, can cause permanent lower extremity muscle weakness in the survivors. Often including the quadriceps, among other proximal lower limb muscles.¹This causes knee instability while standing and walking and thus increases the risk of falling.^{2,3} Compensatory actions to prevent falling, such as excessive knee hyperextension and forward trunk lean, may lead to knee/or back pain³ and fatigue due to the increase in energy cost of walking.^{4,5} These commonly noticed mobility problems in polio survivors¹ might negatively affect functioning in daily life.^{5,7,8} KAFOs are intended to assure safe ambulation³ by ensuring stability during standing and walking and reducing walking energy costs. The most frequently prescribed KAFOs are locked KAFOs and SCKAFOs. Locked KAFOs feature a knee joint that remains locked in both the stance and swing phases of gait, while SC-KAFOs are equipped with a stance-control knee joint that locks during the stance phase but permits knee flexion during swing.¹⁰ These KAFOs often need to be custom-made, as, along with lower extremity muscle weakness, many polio survivors have contractures and misalignment of the joints. While (custom-made) KAFOs are commonly applied in the rehabilitation treatment of polio survivors for lower extremity muscle weakness with knee instability. Little research has been done on the efficacy of these orthotic devices. The rehabilitation researcher could discern the need for a device that would allow knee flexion to obtain free knee motion during the swing phase and provide adequate knee stability for weight bearing in the stance

phase. KAFOs have a hinge knee joint mechanism that provides knee stability for weight bearing by locking the knee joint. But it prevents free knee motion in the swing phase, leading to an unnatural gait pattern. Many survivors sustain quadriceps weakness or knee instability because of paralysis, spinal cord injury, or poliomyelitis. They are commonly prescribed with KAFOs, mechanical devices, for walking. It gives knee stability and prevents collapse in standing and the stance phase. The knee is locked in full extension throughout the gait cycle in KAFO with a drop lock knee joint. Hence the knee joint movement is prevented during the swing phase. Since KAFO resists free knee motion during the swing phase thus, individuals have to compensate for it with unnatural gait patterns. Hip hiking, circumduction, and contralateral foot vaulting are observed due to compensatory gait patterns during the swing phase to attain ground clearance and advance the involved knee.^{11, 12} Walking with a locked knee leads to more energy expenditure.¹³ Traditional KAFOs limit the ability of users to walk on irregular or inclined surfaces, ascend and descend stairs, and step over obstacles because of inadequate toe clearance. Moreover, long-time use of a locked knee KAFO and walking with an abnormal gait may lead to pain and joint dysfunction of the hip and lower back. The absence of knee flexion at the heel strike results in abrupt initial loading, disrupting the smooth progression of the body's center of mass (COM). Walking with conventional KAFOs can also lead to premature exhaustion during ambulation and limited mobility, pain, and decreased range of motion (ROM) in lower

limb joints. The study aimed to evaluate the potential of the indigenously developed SCKAFO with electro-magnetically controlled knee joint by determining its effect on spatiotemporal gait parameters, the physiological cost index (PCI), and improving quality of life in poliomyelitis patients compared to when walking with a KAFO with drop lock knee joint.

MATERIALS & METHODS

Five subjects of poliomyelitis were selected by convenience sampling in the study. As per the inclusion criteria, only those subjects were included who routinely used KAFOs either unilaterally or bilaterally with drop lock knee joint and the presence of sufficient hip flexor strength to advance the affected limb during the swing phase. Exclusion criteria included the existence of impaired cognition, poor balance, and joint contractures greater than 15° at the hip, 10° at the knee, or 5° at the ankle. Muscle strengths at the hip joint were manually assessed and required a minimum of level 3 based on the Oxford scale. Before recruiting the subjects in this study, informed consent was obtained from all the subjects.

All the subjects using KAFO with drop lock knee joints are fitted with SCKAFO. They reported to the Institute for ten days for a standardized training program consisting of five two-hour weekly sessions. They included passive stretching of the lower extremities, balance training, gait training, donning, and doffing of the orthosis. This treatment was performed under a controlled and supervised environment for the patient to acquire confidence and balance, standing and walking with the orthosis. This ensured each subject could walk independently with the orthoses before participating in this study's data collection.

Mechanics of SCKAFO:

Each subject already using KAFO with drop lock knee joint was fitted with the KAFO with electromagnetically controlled knee joint. In SCKAFO, one side of the knee-ankle-foot-orthosis consists/incorporated a drop-lock knee joint without a lock. The indigenously developed stance control knee joint is on the opposite side. In the female part of the developed knee joint, a space is created to fit the locking mechanism inside when the knee joint is locked.

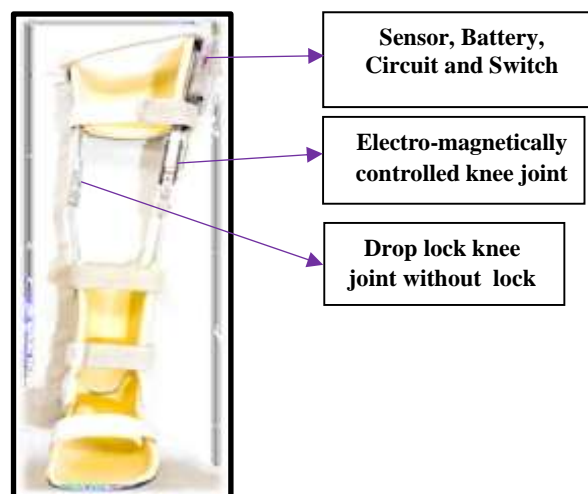

Fig.1: Indigenously developed Knee-ankle-foot orthosis with stance control knee joint

A solenoid switch is used for the locking mechanism. A metal pin is attached to the solenoid that drops in the groove that is made in the joint. A gyroscope sensed the hip's

angle and sent a signal to the solenoid to lock or unlock the knee joint. The hip's angle of flexion and extension is programmed according to each patient.

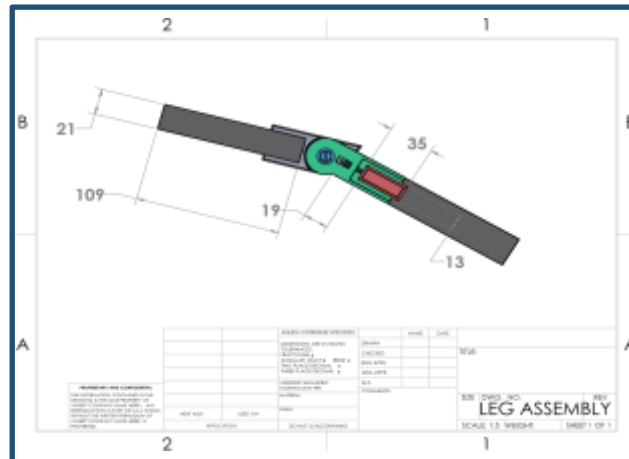

Fig.2: CAD drawing of indigenously developed stance control knee joint



Fig.3: Solenoid

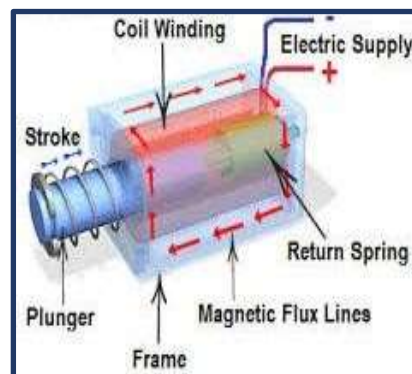

Fig.4: Working of a Solenoid

Battery and electronic unit were attached to the lateral upright of the SCKAFO. A single rechargeable 12 V lithium-ion polymer battery was used to power the actuator. It is a low-maintenance battery, and offers an

advantage that most other chemistries cannot claim. Also, the self-discharge was less than half compared to nickel-cadmium. Lithium-ion cells cause little harm when disposed of.



Fig.5: Solenoid used in indigenously developed knee joint with pin attachment and an acrylic block



Fig.6: Battery and Charger used for the developed knee joint

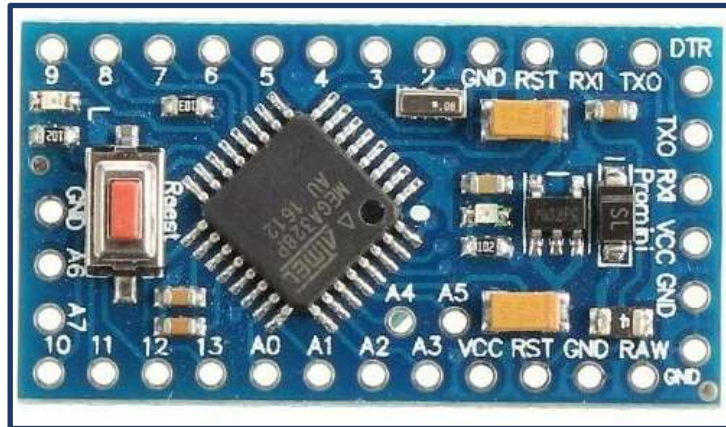

Fig.7: Arduino pro mini board

The Arduino pro mini is for advanced users who require flexibility, compact size, and low cost. The Arduino pro mini board is programmed by Arduino Software (IDE).

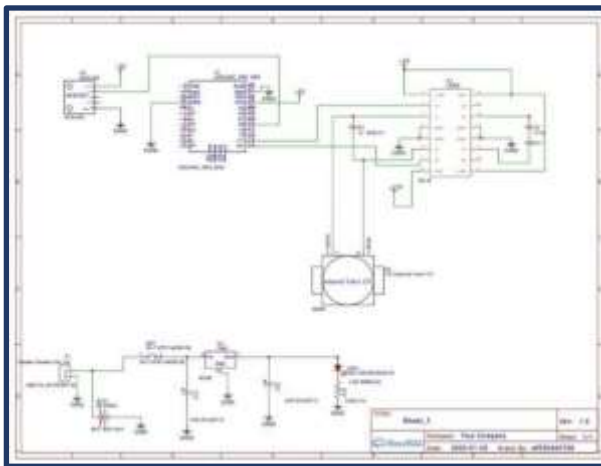

Fig.8: Circuit diagram

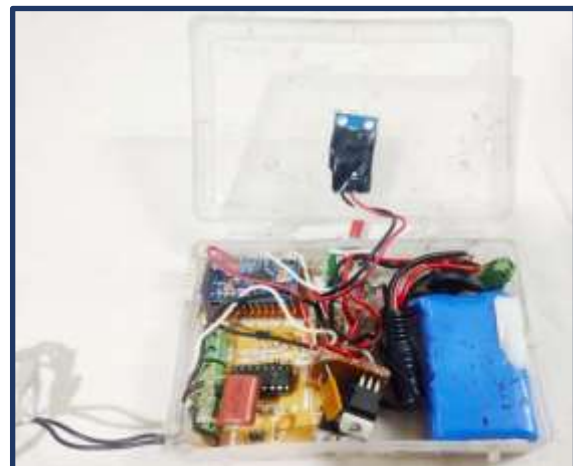

Fig.9: Circuit, Battery, Sensor and Arduino pro mini board box

Control of the orthosis:

When the knee-ankle-foot orthosis with the indigenously developed stance control knee joint is fitted to the patient, the angle of flexion and extension of the hip is set in the Arduino program.

In the gait cycle, the hip is in extension when the limb is in a pre-swing phase. When the hip reaches the angle set for unlocking the joint, a magnetic field is created around the solenoid, which pulls the pin upwards, unlocking the knee joint for the limb to proceed to the swing phase flexing the knee to clear the ground.

At the heel strike, when the hip reaches the flexion angle set in the program, the solenoid pin drops in the slot locking the knee joint for the tibia to translate forward, giving the patient a secured stance phase.

The knee joint is locked till the hip reaches the extension angle set in the program to unlock the knee for the swing phase.

Statistical Analysis

SPSS 20.0 statistical software was used for data analysis. A paired t-test was administered to analyze the data to compare the effectiveness of the two orthoses. Data were analyzed at a 95% confidence interval. The normality of the data was tested with the Wilcoxon test.

RESULT

This study evaluated the effect of the new SCKAFO on the spatiotemporal gait parameters, PCI of walking, and quality of life in poliomyelitis patients. The results demonstrated that using the SCKAFO orthosis significantly increased the outcome

measures. The outcome measures spatiotemporal gait parameters, PCI, and HQOL index score when walking with a locked knee KAFO as a control condition and a SCKAFO are shown in table 1. There was a statistically significant increase in both step length ($p=0.031$) and walking speed ($p=0.035$) when ambulating with the SCKAFO compared to a locked KAFO. (Table 1) The SCKAFO also significantly reduced the PCI of walking compared to the

KAFO with the drop lock knee joint ($p=0.035$). (Table 1) The HQOL index score was significantly increased when walking with the SCKAFO compared to the KAFO with the drop lock knee joint ($p=0.036$) (Table 1) which depicts the quality of life of poliomyelitis patients was improved when they walked with SCKAFO. The study showed no significant difference in stride length and cadence between KAFOs with two types of knee joints.

Table 1 : p-value of spatiotemporal parameters, PCI, and HQOL index in the analysis of the efficacy of Knee-Ankle-Foot Orthosis with drop lock knee joint and Stance control Knee-Ankle-Foot Orthosis with mean and standard deviation, at 95% confidence interval (* significant at $p<0.05$)

Gait Parameters	KAFO with drop lock knee joint		Stance control Knee Ankle Foot Orthosis		t-value	P value
	Mean	SD	Mean	SD		
Step length (meter)	0.46	0.104	0.50	0.109	3.2*	P- 0.031
Stride length (meter)	0.95	0.18	1.02	0.19	1.7	P- 0.16
Cadence (steps/ minute)	80.4	2.4	82.6	3.5	2.2	P- 0.08
Speed (meter/second)	0.78	0.08	0.82	0.10	3.1*	P- 0.035
Physiological Cost Index (PCI) (beats/meter)	29.4	20.6	14.1	7.7	3.1*	P- 0.035
Health Quality of Life Index (HQOL) score	53.4	9.26	58.20	7.72	2.7*	P- 0.036

All five subjects exhibited improved spatiotemporal parameters when walking with the SCKAFO. (Table 1) Walking speeds were increased for all five subjects when walking with SCKAFO. (Figure 13) Increased cadence was observed in four subjects with SCKAFO. Increased step and stride length were also noted with the

SCKAFO. (Figure 10, 11) It was observed that subjects exhibited more symmetry and fewer extraneous trunk and pelvic movements when walking with the SCKAFO. The gait patterns of the patients walking with a SCKAFO were consistently assessed and were found to be more symmetrical and natural.

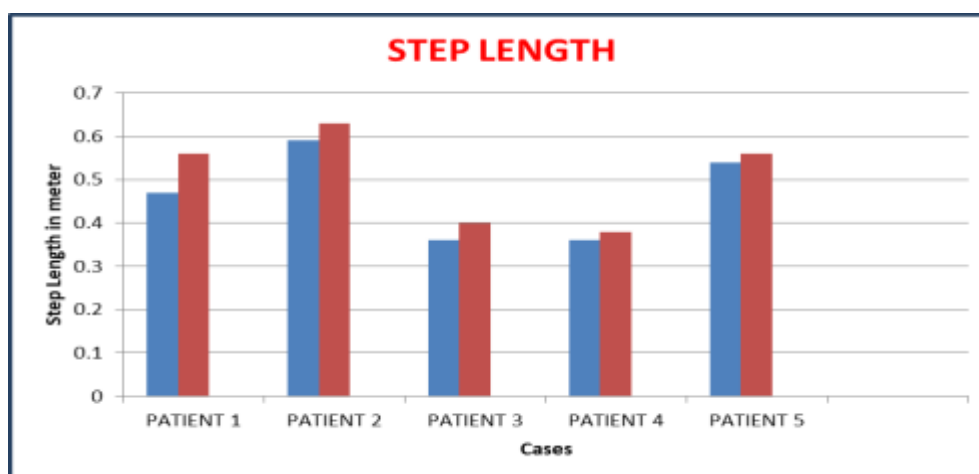

Fig. 10: The graph depicts that the step length in KAFO with stance control knee joint is consistently more in all five cases

Manoj Kumar Tiwari et.al. A comparative study of the effectiveness of indigenously developed Knee-ankle-foot orthosis with stance control knee joint and Knee-ankle-foot orthosis with drop lock knee joint in post-polio residual paralytic patients

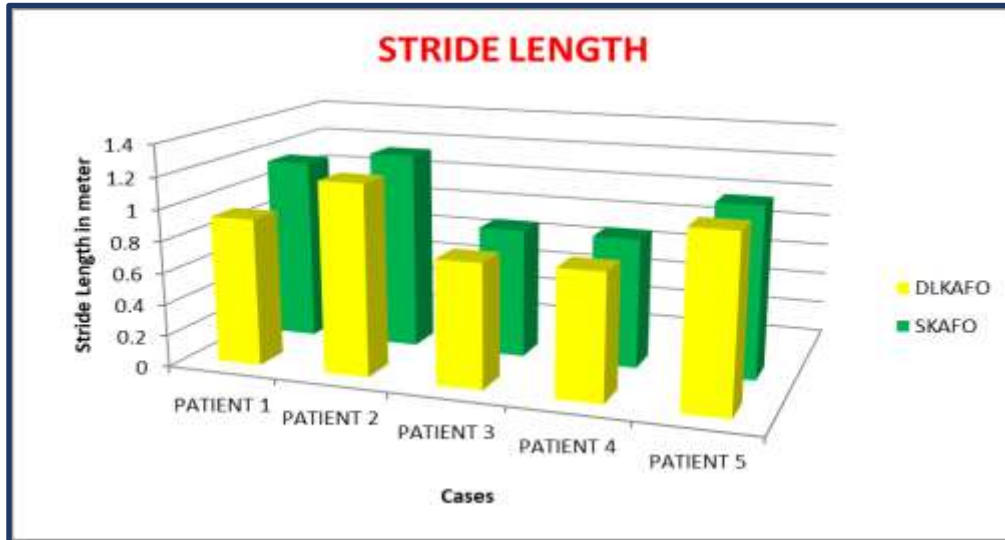

Fig. 11: This graph shows that the stride length in KAFO with stance control knee joint is increased in all five subjects

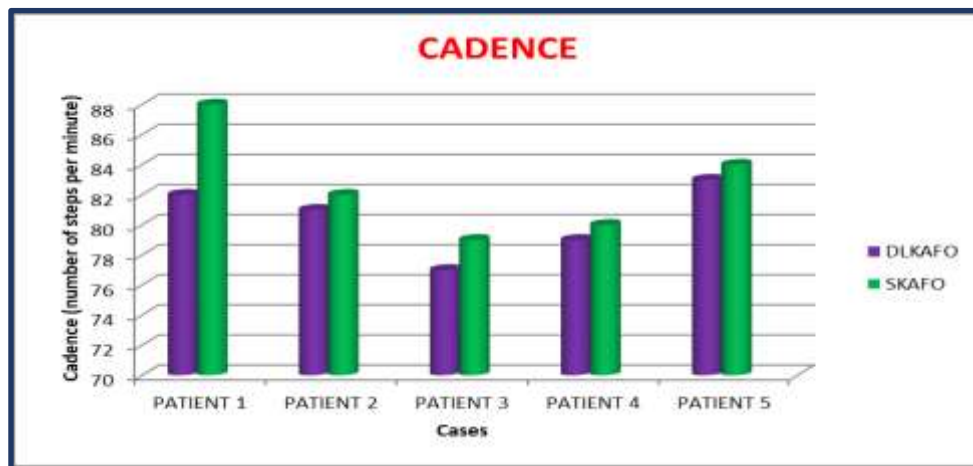

Fig.12: This chart signifies the effectiveness of Stance control Knee-Ankle-Foot orthosis (SKAFO) in increasing cadence due to ease of ground clearance in SKAFO

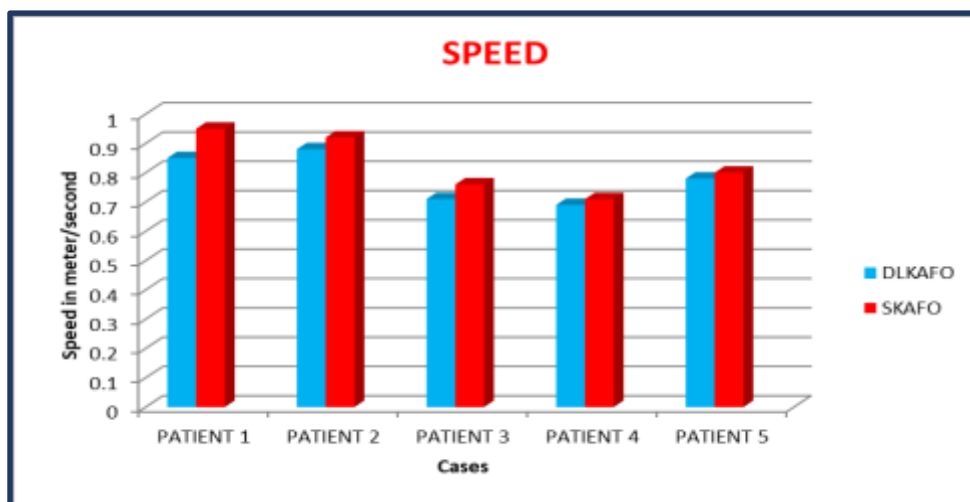

Fig.13: Speed is increased with SKAFO as shown in this chart in poliomyelitis patients

An Orthotics Prosthetics Users survey for Health Quality of life (OPUS: HQOL) was

administered, and it was found that there was significant improvement ($p=0.03$) in the

HQOL with the SCKAFO in all poliomyelitis patients.

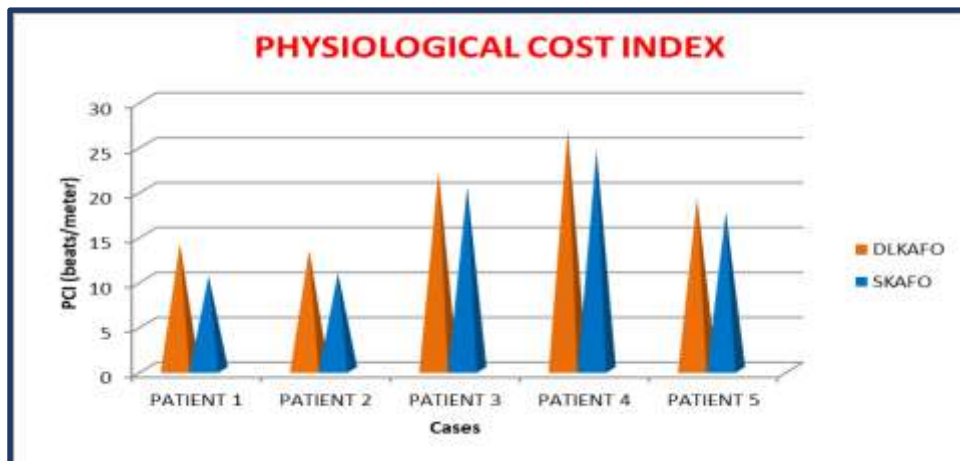

Fig.14: PCI of walking in poliomyelitis patients with stance control KAFO and KAFO with drop lock knee joint

In the device satisfaction survey, all five subjects offered spontaneous comments, and it was also noted that they were more satisfied with the SCKAFO than with the locked KAFO. Subjects did not prefer walking with the locked KAFO, even for the short

distances required for the gait trials. They expressed greater comfort; they walked more comfortably and were more functional when wearing the SCKAFO. All five subjects indicated a more significant measure of safety with the SCKAFO.

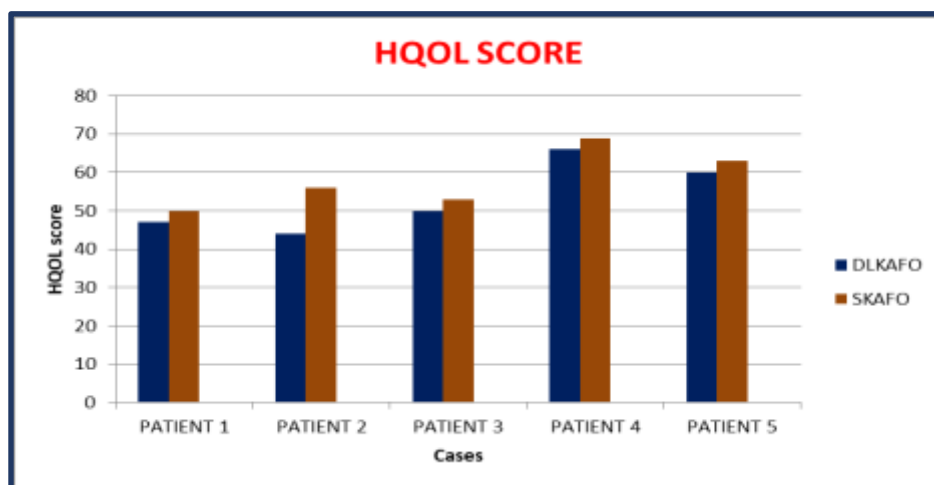

Fig. 15: OPUS-HQOL index score with KAFO with drop lock knee joint and KAFO with the stance control knee joint

DISCUSSION

The purpose of this study was to evaluate the effect of newly developed SCKAFO use on walking efficacy in poliomyelitis patients. Recommended indications are different for SCKAFOs compared to KAFOs. Subjects with lower limb weakness can use a KAFO with a drop-locked knee joint. Users with sufficient hip strength of at least Grade 3. Impaired cognition, knee-flexion contracture $>10^\circ$, moderate to severe spasticity of the

hamstring, lack of hip abductors in bilateral patients, uncorrectable genu varum/valgum $>10^\circ$, lack of motivation or inappropriate expectations, and body weight >140 kilograms are all contraindication for using SCKAFOs.³⁶

The provision of reduced energy consumption has been quoted as one of the main aims and reasons for subjects with lower limb weakness to walk with a SCKAFO. Due to paralysis of the lower limb

muscles, KAFO users are forced to walk with the knee in a locked position, hip hiking strategy, leg circumduction, or a vaulting gait. This can cause soft tissue injury, increased walking effort, and a high energy consumption rate in KAFO users. Only three studies evaluated this parameter in poliomyelitis subjects when wearing SCKAFO compared to a locked KAFO.^{26, 28, 29}

The knee joint must have approximately 70° of flexion available in normal walking, but SCKAFOs have not demonstrated that they can provide this amount of flexion. Future designs of SCKAFOs must consider this limitation by providing more knee flexion. In addition, stance phase flexion must be developed in new designs of SCKAFOs to provide flexion during loading response and late stance as stance phase knee flexion plays a shock-absorbing role and smoothes the COM trajectory during normal walking.

All five subjects exhibited a more symmetrical gait with less compensatory movement when wearing the SCKAFO. With longer steps and increased cadence, their walking speed improved when the knee moved freely during the swing phase of gait. These changes created a more "normal looking," more aesthetic walking pattern which was in line with the other studies.^{13,17,20}

Still, the improved symmetry and decreased compensatory movements also reduced the energy cost for walking and enhanced function by allowing subjects to walk without fatigue. Lowering the need for excessive movement of the pelvis and trunk should also reduce the risk of dysfunction and long-term musculoskeletal pain resulting from compensating for a stiff knee altered biomechanics.

An orthotic device is useful only if the individual wears it regularly. Although the information gathered in this study was anecdotal, all subjects volunteered statements in favor of their SCKAFO versus a locked KAFO. This suggests that SCKAFOs may increase patient acceptance compared with locked KAFOs. Patients have rejected many

KAFOs for the reasons they echoed in the study: one cannot ambulate comfortably, easily, or very far when using a KAFO with a drop-lock knee joint.

The OPUS-HQOL and OPUS satisfaction with device and services have shown positive results towards the newly developed joint. This is similar to the findings of the other studies conducted to evaluate SCKAFO. The study's number of participating subjects was small, so the findings cannot be generalized to the larger population. More studies are therefore needed to analyze this effect further. A more comprehensive evaluation of kinematic and temporospatial parameters and an electromyographical analysis may assist in understanding underlying training or orthotic effects of KAFO use. Evaluation of this orthosis on a further cohort of patients utilizing longer training periods for walking in subjects with quadriceps weakness will also be beneficial.

The design and construction of more advanced SCKAFOs as future designs of orthosis for use in the rehabilitation of walking in KAFOs users; an investigation into the effect of SCKAFOs on COM displacement and stability in quiet standing; although cosmesis was not evaluated in using SCKAFOs, consideration should be given to improving cosmesis of walking when KAFO users wear this type of orthoses.

CONCLUSION

In summary, it can be determined that SCKAFO is beneficial in providing a more physiological gait pattern, reduction of compensatory movements, enhanced walking speed, lower energy consumption, and greater patient satisfaction. The SCKAFO appears to be an alternative to the traditional locked KAFO for some patients with lower limb dysfunction. It provides knee flexion and greater ROM for the knee in the swing phase with greater ground clearance. It lowers pelvic obliquity on the affected side and eliminates pelvic obliquity in the stance phase on the sound side. All five subjects exhibited improved spatiotemporal gait

parameters and a more symmetric gait when walking with the SCKAFO versus the locked knee KAFO. All five subjects reported greater satisfaction with the SCKAFO than the locked knee KAFO. It was evident from the findings that the quality of life of poliomyelitis patients was significantly improved when walking with SCKAFO.

Acknowledgment

We are deeply grateful to all the patients who participated in the study. The authors thank Mrs. Priyadarsini Monalisha Dash and Ms. Mrunali Kalkotwar for their valuable support in data analysis. We thank Mr. Ajay Sonavane for his immense support in editing the draft manuscript.

Conflict of Interest: None

Ethical Approval: Approved

REFERENCES

1. Nollet F, Beelen A, Prins MH, de Visser M, Sargeant AJ, Lankhorst GJ, et al. Disability and functional assessment in former polio patients with and without postpolio syndrome. *Arch Phys Med Rehabil* 1999; 80: 136-143.
2. Bickerstaffe A, Beelen A, Nollet F. Circumstances and consequences of falls in polio survivors. *J Rehabil Med* 2010; 42: 908-915.
3. Perry J, Clark D. Biomechanical abnormalities of post-polio patients and the implications for orthotic management. *NeuroRehabilitation* 1997; 8: 119-138.
4. Behm MA, Nollet F, Harlaar J. Energy demands of walking in persons with post poliomyelitis syndrome: relationship with muscle strength and reproducibility. *Arch Phys Med Rehabil* 2006; 87: 136-140.
5. Lygren H, Jones K, Grenstad T, Dreye V, Farbu E, Rekand T. Perceived disability, fatigue, pain and measured isometric muscles strength in patients with post-polio symptoms. *Physiother Res Int* 2007; 12: 39-49
6. Eradication of Polio. <https://www.economist.com/graphic-detail/2019/08/21/africa-is-on-track-to-be-declared-polio-free>
7. Bickerstaffe A, Beelen A, Nollet F. Change in physical mobility over 10 years in post-polio syndrome. *Neuromuscular Disord* 2015; 25: 225-230.
8. Jensen MP, Alschuler KN, Smith AE, Verrall AM, Goetz MC, Molton IR. Pain and fatigue in persons with postpolio syndrome: Independent effects on functioning. *Arch Phys Med Rehabil* 2011; 92: 1796-1801.
9. Hachisuka K, Makino K, Wada F, Saeki S, Yoshimoto N. Oxygen consumption, oxygen cost and physiological cost index in polio survivors: a comparison of walking without orthosis, with an ordinary or a carbon-fiber reinforced plastic knee ankle foot orthosis. *J Rehabil Med* 2007; 39: 646-650.
10. Hsu JD, Michael JW, Fisk JR. AAOS atlas of orthoses and assistive devices. 4th edn. F. Nollet CTN, editor. Philadelphia: Mosby; 2008
11. McMillan AG, Kendrick K, Michael JW, Aronson J, Horton GW (2004) Preliminary evidence for the effectiveness of a stance control orthosis *J Prosthet Orthot* 16(1); 6-13.
12. Kerrigan DC, Frates EP, Rogan S, Riley PO (2000) Hip hiking and circumduction: quantitative definitions. *Am J Phys Med Rehabil* 79:247-253
13. Mattsson E, Brostrom LA (1990) The increase in energy cost of walking with an immobilized knee or an unstable ankle. *Scand J Rehabil* 79:247-252
14. Das A.K, Maitra T.K, Acharyya B. Management of Post-Polio Residual Paralysis of Lower Limb In Present Indian Scenario. *Indian Journal of Orthopedics*. 2004. Vol 38. Issue 4; 226-232.
15. Lovegreen W, Kwasniewski M, Panchang P, Smith M. 27 – Orthotic Management of Polio and Post-polio Syndrome. *Atlas of Orthoses and Assistive Devices (Fifth Edition)* 2019, Pages 277-288.e2.
16. [http://www.cascadeorthotics.com/knee-ankle-foot-orthosis-kafo-cascade-orthotics/Knee ankle foot orthosis](http://www.cascadeorthotics.com/knee-ankle-foot-orthosis-kafo-cascade-orthotics/Knee%20ankle%20foot%20orthosis). Cascade Orthotics Ltd.
17. Rafiaei M, Bahramzadeh M, Arazpour M, Samadian M, Hutchins S, Farah and Mohammad Mardani. The gait and energy efficiency of stance control knee- ankle-foot orthoses: A literature review. 2015. 1-13.
18. <http://www.hangerclinic.com/bracing-support/adult-le/Pages/Stance-Control->

- Orthoses.aspx Stance Control Orthosis. Hanger Clinic.
19. Jung-Hwan K, Sang-Goo J, Kang-Jae J, Jae-Hyung K. Therapeutic Experience on Stance Control Knee-Ankle-Foot Orthosis with Electromagnetically Controlled Knee Joint System in Poliomyelitis. *Annals of rehabilitation medicine*.2016; 40(2):356-361.
 20. Arazpour M, Samadian M, Hutchins SW, Bani MA and Curran S. The physiological cost index of walking with a powered knee-ankle-foot orthosis in subject with poliomyelitis: A Pilot Study. 2015; 40(4), 454-459.
 21. Mehndiratta MM, Mehndiratta P, Pande R. Poliomyelitis -Historical Facts, Epidemiology, and Current Challenges in Eradication. *The Neurohospitalist*. 2014,4 (4): 233-229.
 22. Agarwal AK. Poliomyelitis. *Essentials of Prosthetics and Orthotics*. First edition.2013.
 23. Arazpour M, Chitsazan A, Bani MA, Rouhi G, Ghomshe FT, Hutchins SW. The effect of a knee ankle foot orthosis incorporating an active knee mechanism on the gait of a person with poliomyelitis. *Prosthetics and Orthotics International*. Jan 2013. 37(5); 411-4.
 24. Zacharias, Dipl-Ing B, Kannenberg, Andreas. Clinical Benefits of Stance Control Orthosis Systems: An Analysis of the Scientific Literature. *Journal of Prosthetics and Orthotics*. 2012. Volume 24 - Issue 1 - p 2-7.
 25. Park K. Park's textbook of Preventive and Social Medicine. Poliomyelitis. 21st edition. 2011. Pg 183-189.
 26. Davis P, Bach MT, Pereira MD. The Effect of Stance Control Orthoses on Gait Characteristics and Energy Expenditure in Knee-Ankle-Foot Orthosis Users. *Prosthetics and Orthotics International*. June 2010; 34(2): 206-215.
 27. Yakimovich T, Lemaire D, Kofman J. Engineering design review of stance-control knee-ankle-foot orthoses. *Journal of rehabilitation research and development*. Volume 46, Number 2, 2009; Pages 257-268.
 28. Zissimopoulos A, Fatone S, Gard S. Biomechanical and energetic effects of a stance-control orthotic knee joint. *Journal of rehabilitation research and development*. 2007; Volume 44, number 4, 503-514.
 29. Hebert J, Liggins A. Gait Evaluation of an Automatic Stance-Control Knee orthosis in a patient with Post-Poliomyelitis. Volume 86, Issue 8, August 2005, Pages 1676-1680.
 30. Merel-Anne Brehm, MSc, Frans Nollet, MD, PhD, Jaap Harlaar, PhD. Energy Demands of Walking in Persons with Post-Poliomyelitis Syndrome: Relationship with Muscle Strength and Reproducibility. *Arch Phys Med Rehabil* 2006; 87:136-40.
 31. DiBello T, Kelley C, Vallbona C, Kaldis T. Orthoses for persons with post-polio sequelae. *Atlas of orthosis and assistive devices – Fourth edition*.1997. 419-429.
 32. Rose J, Gamble J. *Gait Analysis: Clinical Application*. Polio Gate Problems. *Human Walking – Second Edition*.1994.141-163.
 33. Kenton R. Kaufman, Ph.D., PE, and Steven E. Irby, MS. Ambulatory KAFOs: A Biomechanical Engineering Perspective. *JPO Journal of Prosthetics and Orthotics*: June 2006 - Volume 18 - Issue 7 - p P175-P182.
 34. Cashman N, Siegel I, Antel J. Post-polio syndrome: An Overview. *O&P Library*. 1987, Vol 11, Num 2:74-78.
 35. Eriksson M, Jylli L, Villard L, Kroksmark A, Bartunek A. Health-related quality of life and orthosis use in a Swedish population with arthrogryposis. *Prosthetics and Orthotics International* 2018, Vol. 42(4) 402-409.
 36. Ottobock Freewalk. <https://www.ottobockus.com/orthotics/solution-overview/stance-control-knee-brace-free-walk/>
- How to cite this article: Manoj Kumar Tiwari, Yogeeta Madkaikar, Anil Kumar Gaur et.al. A comparative study of the effectiveness of indigenously developed Knee-ankle-foot orthosis with stance control knee joint and Knee-ankle-foot orthosis with drop lock knee joint in post-polio residual paralytic patients. *Int J Health Sci Res*. 2022; 12(11):140-150. DOI: <https://doi.org/10.52403/ijhsr.20221118>
